

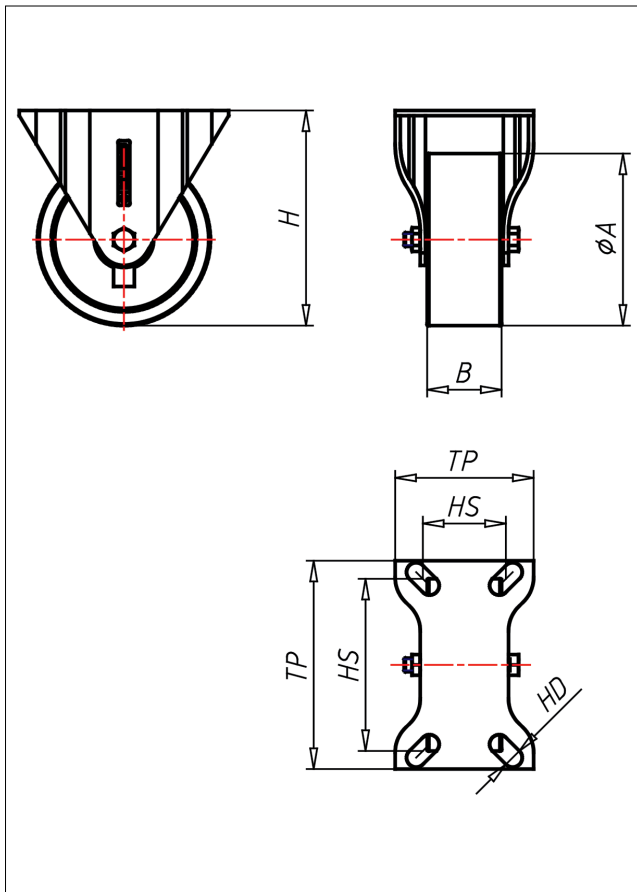

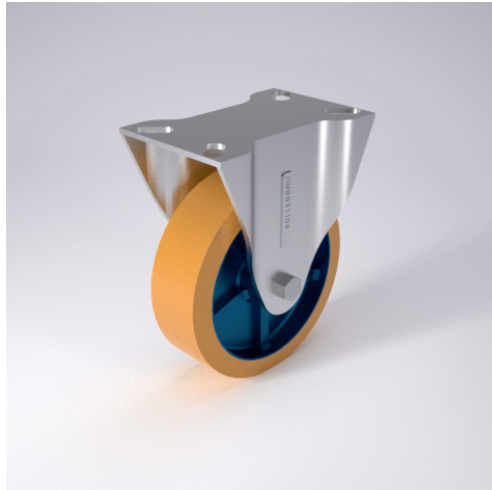





88/81-ZK/SUB

Bockrolle



61-SU



LENKROLLE	LENKROLLE MIT RADFESTSTELLER	BOCKROLLE																				
 <ul style="list-style-type: none"> • geräuscharmer Lauf • geringer Rollwiderstand • abrieb- und reißfest • hohe Stoßfestigkeit • sehr beständig gegen viele aggressive Medien <p>Guss-Polyurethan Felge Gussstahl → Seite 247</p> 	 <p>sehr großes Schwengelager - lange Lebensdauer, Gabelschenkel speziell geformt, Radachse verschraubt - gesichert, verzinkt → Seite 42</p> 	 <p>AUSWAHLHILFE:</p> <table border="1"> <tr> <td>leicht lenkend</td> <td>-</td> <td>+</td> <td>++</td> </tr> <tr> <td>verschleißarm</td> <td>X</td> <td></td> <td></td> </tr> <tr> <td>stoßfest</td> <td></td> <td>X</td> <td></td> </tr> <tr> <td>bodenschonend</td> <td></td> <td>X</td> <td></td> </tr> <tr> <td>witterungsbeständig</td> <td></td> <td>X</td> <td></td> </tr> </table>	leicht lenkend	-	+	++	verschleißarm	X			stoßfest		X		bodenschonend		X		witterungsbeständig		X	
leicht lenkend	-	+	++																			
verschleißarm	X																					
stoßfest		X																				
bodenschonend		X																				
witterungsbeständig		X																				

Technische Details

ORDERNO (Artikel-nummer)	88-100 SUB
WDAB (Rad-Ø A x Breite B / mm)	100x43
LC (Tragkraft / kg)	300
H (Bauhöhe H / mm)	125
TP (Plattengröße / mm)	121x80
HS (Lochabstand / mm)	100x48
HD (Loch-Ø / mm)	11
WB (Radlager)	Rollenlager